



Regenwasser-Erdtank-Carat -S- 2700 I
Rainwater underground tank Carat -S- 2700 I
mit / with Mini-Dom

Artikel-Nr.
Item no.

372024

Dom-Mini 371041

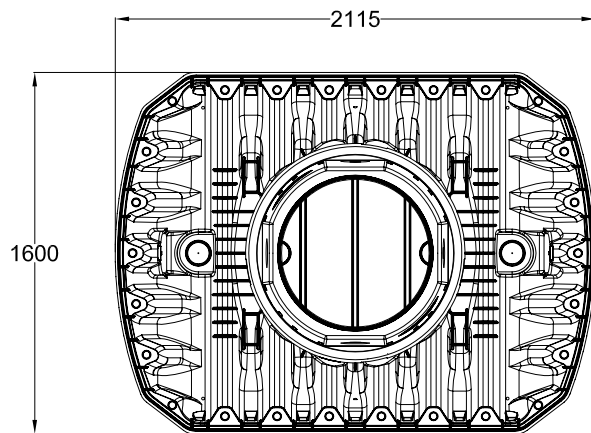
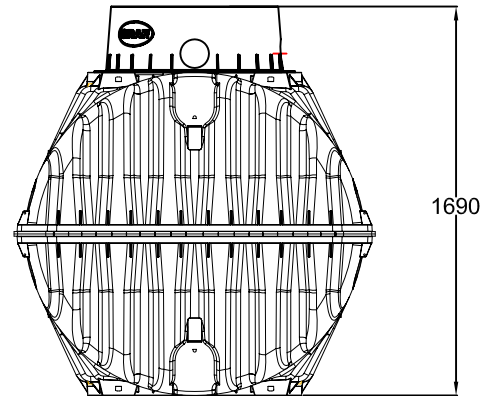
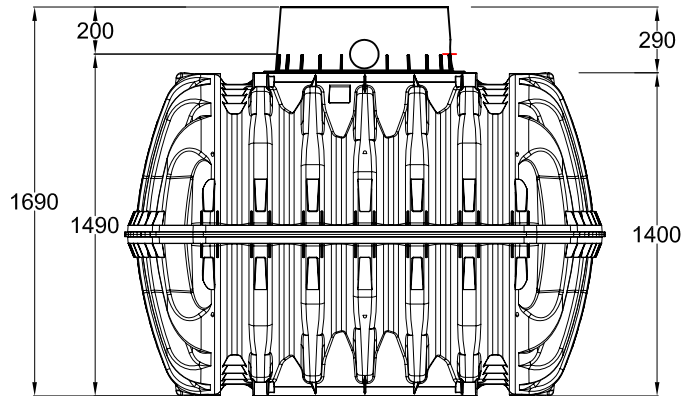

alle Maße +/- 3 % Toleranz
all dimensions +/- 3% tolerance

Otto Graf GmbH
Kunststoffzeugnisse
79331 Teningen

Carl-Zeiss-Str. 2-6
Telefon 07641/589-0
Telefax 07641/589-50
Email: info@graf-online.de
www.graf-online.de

Gewicht/weight 116 kg

Datum/date

Ausgabe/edition 11/09

Name/name

Blatt/page 1 von 1